



BTS3911B

V100R013C10

Product Description

Issue 01

Date 2018-04-20

Copyright © Huawei Technologies Co., Ltd. 2018. All rights reserved.

No part of this document may be reproduced or transmitted in any form or by any means without prior written consent of Huawei Technologies Co., Ltd.

Trademarks and Permissions



HUAWEI and other Huawei trademarks are trademarks of Huawei Technologies Co., Ltd.

All other trademarks and trade names mentioned in this document are the property of their respective holders.

Notice

The purchased products, services and features are stipulated by the contract made between Huawei and the customer. All or part of the products, services and features described in this document may not be within the purchase scope or the usage scope. Unless otherwise specified in the contract, all statements, information, and recommendations in this document are provided "AS IS" without warranties, guarantees or representations of any kind, either express or implied.

The information in this document is subject to change without notice. Every effort has been made in the preparation of this document to ensure accuracy of the contents, but all statements, information, and recommendations in this document do not constitute a warranty of any kind, express or implied.

Huawei Technologies Co., Ltd.

Address: Huawei Industrial Base
Bantian, Longgang
Shenzhen 518129
People's Republic of China

Website: <http://www.huawei.com>

Email: support@huawei.com

Contents

1 BTS3911B Product Description.....	1
1.1 Changes in BTS3911B Product Description.....	2
1.2 Introduction.....	2
1.2.1 Appearance.....	2
1.2.2 Benefits.....	3
1.2.3 Network Architecture and Topologies.....	4
1.2.4 Logical Structure.....	6
1.3 Hardware.....	7
1.3.1 Ports and Indicators.....	8
1.3.2 Auxiliary Devices.....	10
1.3.2.1 PSE Injector.....	10
1.3.3 Cables.....	12
1.3.3.1 Overview.....	13
1.3.3.2 Ethernet Cable.....	14
1.3.3.3 (Optional) RGPS Signal Cable.....	15
1.4 O&M.....	16
1.4.1 O&M Modes and System.....	16
1.4.2 O&M Functions.....	17
1.5 Specifications.....	19
1.5.1 Technical Specifications.....	19
1.5.2 Typical Power Configuration.....	28
1.5.3 Reliability.....	33

1 BTS3911B Product Description

Overview

This document describes the BTS3911B in terms of equipment overview, hardware introduction, operation and maintenance (O&M), and specifications.

Product Version

The following table lists the product version applicable to this document.

Product Name	Product Version
BTS3911B	V100R013C10

Intended Audience

This document is intended for:

- Network planning engineers
- Field engineers
- System engineers

[1.1 Changes in BTS3911B Product Description](#)

This section describes the changes in *BTS3911B Product Description*.

[1.2 Introduction](#)

This section describes the BTS3911B appearance, benefits, network architecture and topologies, and logical structure.

[1.3 Hardware](#)

This section describes the ports, indicators, auxiliary devices, and cables of a BTS3911B.

[1.4 O&M](#)

The O&M system manages, monitors, and maintains BTS3911B software, hardware, and configuration data.

[1.5 Specifications](#)

This section describes the technical specifications and reliability of the BTS3911B.

1.1 Changes in BTS3911B Product Description

This section describes the changes in *BTS3911B Product Description*.

01 (2018-04-20)

This is issue 01.

Compared with Draft A (2018-02-06), this issue does not include any changes.

Draft A (2018-02-06)

This is Draft A.

Compared with issue 03 (2017-08-15) of V100R012C10, this issue does not include any new information.

Compared with issue 03 (2017-08-15) of V100R012C10, this issue includes the following changes.

Topic	Change Description
1.5.1 Technical Specifications	Modified the maximum throughput of the BTS3911B.

No information in issue 03 (2017-08-15) of V100R012C10 is deleted from this issue.

1.2 Introduction

This section describes the BTS3911B appearance, benefits, network architecture and topologies, and logical structure.

The industry-leading BTS3911B is an indoor multimode multiband Pico base station, supporting LTE, UMTS, and Wi-Fi. It helps operators cope with the rapidly increasing traffic volume in the mobile broadband era.

The BTS3911B enables plug-and-play deployment and offers self-configuration features. It does not require equipment room facilities, simplifying site acquisition and network deployment.

1.2.1 Appearance

This section describes the appearance and dimensions of a BTS3911B.

[Figure 1-1](#) shows the appearance of a BTS3911B, which is equipped with internal antennas.

Figure 1-1 Appearance

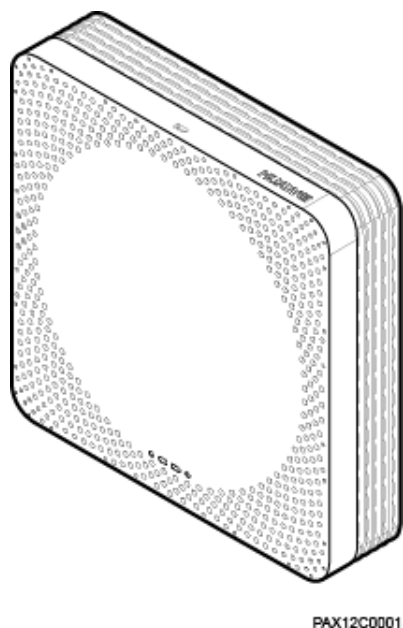

PAX12C0001

Figure 1-2 shows the BTS3911B dimensions.

Figure 1-2 Dimensions

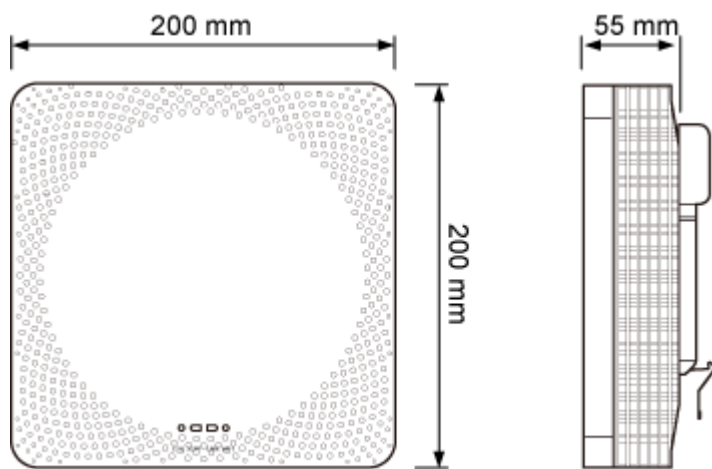

PAX12C0004

1.2.2 Benefits

The BTS3911B uses cost-effective transmission, enables fast network deployment, improves network coverage, and supports Wi-Fi.

Compact Structure and Fast Network Deployment

The all-in-one BTS3911B is easy to install and maintain, reducing capital expenditure (CAPEX) for operators.

The BTS3911B can be installed on walls or ceilings without the need for an equipment room. It has few requirements for site acquisition and enables flexible and fast network deployment, reducing site leasing costs.

Cost-effective Transmission

The BTS3911B supports all-IP transmission and can be deployed in a star topology.

Expanded Capacity and Improved Coverage

The BTS3911B eliminates coverage holes, expands network capacity at hotspots, and improves network coverage, helping operators enhance network quality and improve user experience.

Wi-Fi Support

Purchase and install the Wi-Fi License before enabling Wi-Fi services. However, the license is not required to perform local maintenance over Wi-Fi.

Wi-Fi on the BTS3911B has the following characteristics:

- Concurrent operation of 2.4 GHz and 5 GHz, with both supporting 3x3 MIMO
- 802.11ac

The Wi-Fi processing unit, complying with IEEE 802.11ac, supports 256QAM, 80 MHz bandwidth, and a longer aggregated MAC protocol data unit (AMPDU). The maximum theoretical data rate over the air interface can be up to 1300 Mbit/s.

- High performance and stability

The internal processor provides high throughput and load capability. The stable signal strength and quality ensure a reliable wireless network. Automatic power tuning and frequency adjustment, and load balancing enable a flexible and stable large-scale network.

- High data rates, high receiver sensitivity, and long-distance transmission
- Various network security features
 - Protection against XML denial-of-service (XDoS) attacks
 - Link integrity protection
 - Encryption and authentication

- WLAN authentication and privacy infrastructure (WAPI)
- Wired equivalent privacy (WEP)
- Wi-Fi protected access (WPA)
- WPA2
- 802.1X

NOTE

Due to security risks in WEP and WPA, it is good practice to use WAPI, WPA2, and 802.1X.

1.2.3 Network Architecture and Topologies

This section describes the network architecture and topologies.

Network Architecture

Figure 1-3 shows the BTS3911B on a 3GPP network. **Figure 1-4** shows the BTS3911B on a WLAN.

Figure 1-3 BTS3911B on a 3GPP network

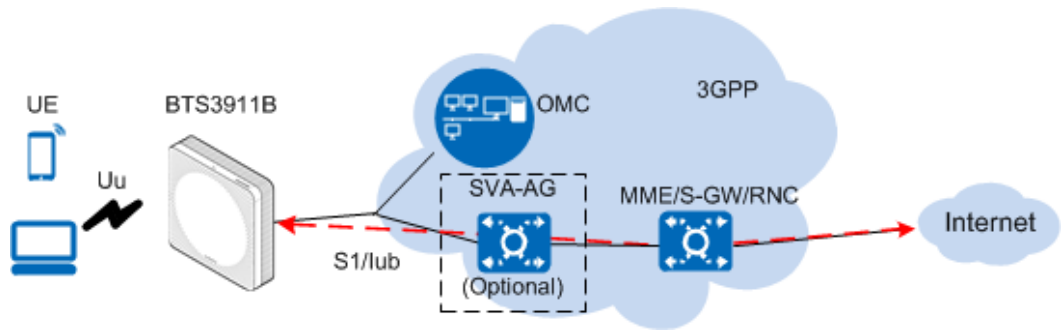

UE: user equipment	OMC: operation and maintenance center	MME: mobility management entity
S-GW: serving gateway	RNC: radio network controller	SVA-AG: Service Anchor Access Gateway

NOTE

The SVA-AG is an optional NE. It can be used in region-based PnP deployment to achieve:

- Triple-plane isolation
- Zero dependence on the transmission pool feature of the BSC6900

For details, see *SVA3200 Product Description*.

Figure 1-4 BTS3911B on a WLAN

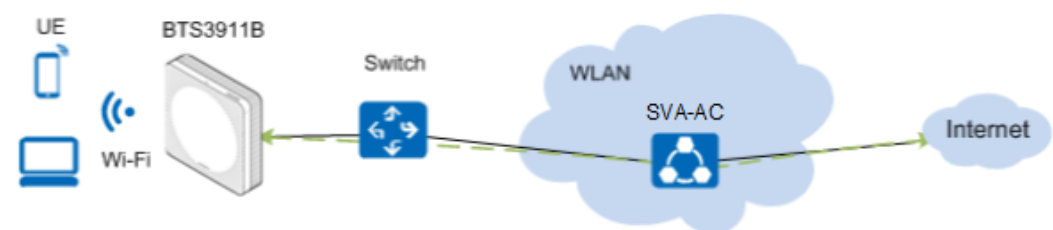

UE: user equipment	AC: access controller	AP: access point
--------------------	-----------------------	------------------

The BTS3911B on a WLAN works as a bridge to transmit data. The AC is responsible for user access, AP registration, authentication, routing, AP management, security protocol configuration, and QoS management.

NOTE

For details about AC installation, deployment, and maintenance, see *SVA3200 Product Description*.

Topologies

BTS3911Bs support the star topology over IP networking. [Figure 1-5](#) shows the star topology.

Figure 1-5 Star topology

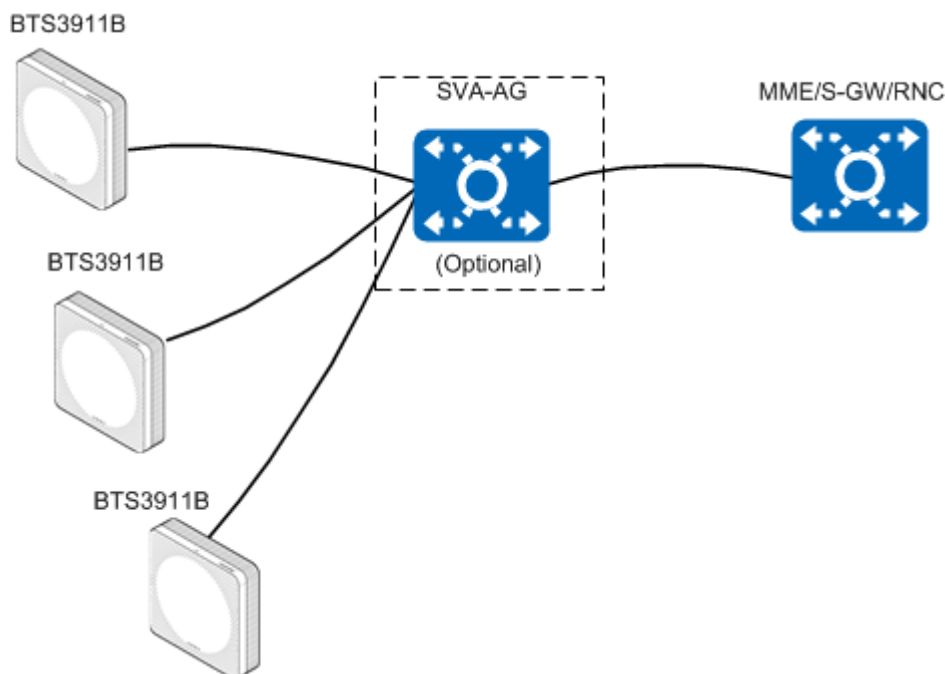

Advantages:

- Each BTS3911B is connected directly to the SVA-AG over the transport network. If the SVA-AG is not deployed, each BTS3911B is connected directly to the MME/S-GW/RNC. The star topology decreases networking complexity, and facilitates engineering implementation, maintenance, and capacity expansion.
- Each BTS3911B directly exchanges data with the SVA-AG. If the SVA-AG is not deployed, each BTS3911B directly exchanges data with the MME/S-GW/RNC. Signals travel through only a few nodes so that data transmission has high reliability.

Disadvantage: The star topology requires more transmission resources, compared to other topologies.

1.2.4 Logical Structure

The BTS3911B consists of a transmission and interface unit, main control unit, baseband processing unit, clock unit, radio frequency (RF) unit, Wi-Fi processing unit, and antenna processing unit.

[Figure 1-6](#) shows the logical structure of the BTS3911B.

Figure 1-6 Logical structure of the BTS3911B

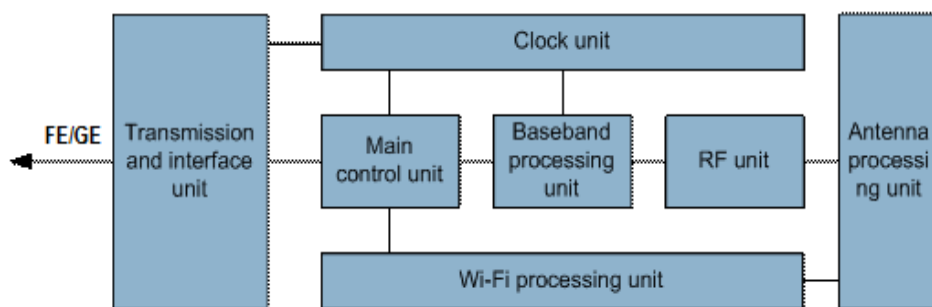

The functional units are detailed as follows:

- **Transmission and interface unit**
Forwards data between a transport network and the BTS3911B, providing:
 - Physical port between the BTS3911B and the transport network
 - User-plane interface between the BTS3911B and other NEs
- **Main control unit**
Controls and manages resources in the BTS3911B, providing:
 - Management-plane interface between the BTS3911B and the NMS
 - Control-plane interface between the BTS3911B and other NEs
 - Interface for controlling common resources in a multimode BTS3911B
- **Clock unit**
Synchronizes clock signals. The clock source can be:
 - RGPS
 - IEEE 1588v2
 - Synchronous Ethernet
- **Baseband processing unit**
Processes uplink and downlink baseband data.
- **RF unit**
Performs modulation, demodulation, and data processing for baseband and RF signals.
- **Antenna processing unit**
Serves as an antenna for uplink and downlink services and the sniffer module (used only for detecting neighboring cells).
- **Wi-Fi processing unit**
Processes Wi-Fi data.

NOTE

The management virtual access point (VAP) function of the Wi-Fi processing unit is used to perform O&M on the BTS3911B.

1.3 Hardware

This section describes the ports, indicators, auxiliary devices, and cables of a BTS3911B.

1.3.1 Ports and Indicators

This section describes the ports and indicators.

Figure 1-7 shows the ports on the rear and the indicators on the front.

Figure 1-7 Ports and indicators

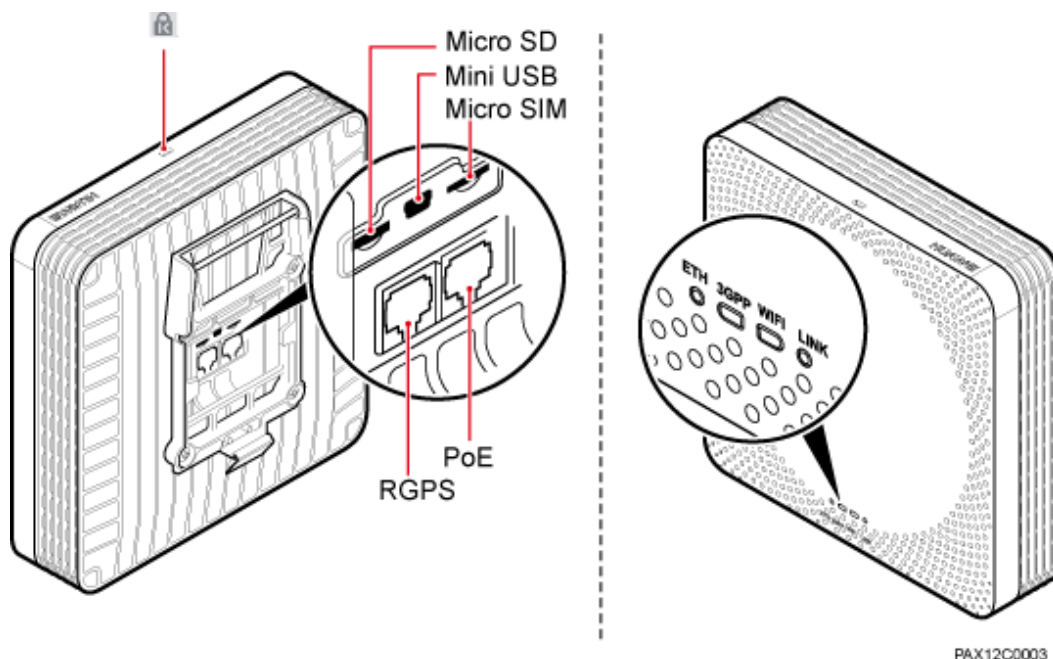

Table 1-1 describes the ports and slots.

Table 1-1 Ports and slots

Port/Slot	Description
Micro SD	Used for housing a MicroSD card. This is used for deployment.
Mini USB	Used for testing clock output in the production assembly stage.
Micro SIM	Used for housing a micro SIM card. This is reserved for EAP-AKA authentication.
RGPS	Used for clock synchronization.
PoE	Used for power supply and data transmission.
	Used for anti-theft of the BTS3911B. Anti-theft locks are not included, and can be supplied by customers if required.

Table 1-2 describes the four indicators, which signify the BTS3911B's operating status.

Table 1-2 Indicators

Silk screen	Meaning	Status	Description
3GP P	Cellular processing unit status	Blinking white (on for 0.125s and off for 0.125s)	The cellular processing unit's high-level software is being loaded.
		Blinking white (on for 1s and off for 1s)	The cellular processing unit cell is starting up.
		Steady white	All cellular processing unit cells are set up successfully. S1 links and O&M links are functional.
		White is off	The cellular processing unit is not powered on.
		Blinking orange (on for 0.125s and off for 0.125s)	An upgrade using a MicroSD card has failed. This is the reserved status.
		Blinking orange (on for 1s and off for 1s)	IKE negotiation has failed for the cellular processing unit.
		Steady orange	The cellular processing unit is faulty. Replace the BTS3911B.
		Alternating orange and white (on for 0.125s and off for 0.125s)	An upgrade using a MicroSD card is in progress. This is the reserved status.
		Orange is off	No hardware-related alarm is generated on the cellular processing unit.
ETH	ETH status	Blinking white	Data transmission over the Ethernet port is normal.
		Steady white	An Ethernet cable is correctly connected to the Ethernet port.
		Steady off	An Ethernet cable is incorrectly connected to the Ethernet port.
WIF I	Wi-Fi processing unit status	Blinking white (on for 0.125s and off for 0.125s)	The Wi-Fi processing unit is being powered on and software is being loaded.
		Blinking white (on for 1s and off for 1s)	The Wi-Fi processing unit is starting up.

Silk screen	Meaning	Status	Description
		Steady white	The Wi-Fi processing unit is providing services properly and the O&M link is functional.
		White is off	The Wi-Fi processing unit is not powered on.
		Steady orange	The Wi-Fi processing unit is faulty. Replace the BTS3911B.
		Orange is off	No hardware-related alarm is generated on the Wi-Fi processing unit.
LINK	Link status	Steady white	The CAPWAP link is normal.
		Steady orange	The CAPWAP tunnel is disconnected.
		Steady off	The Wi-Fi processing unit does not obtain an IP address.

 **NOTE**

- While the BTS3911B is being powered on, the 3GPP indicator is steady orange or steady white for a short period of time and there is no need to check the 3GPP indicator status.
- If the CAPWAP tunnel is disconnected, the LINK indicator will not instantly turn steady orange. The default delay time is 25 x 6s. The delay time can be modified on the AC.

1.3.2 Auxiliary Devices

This section describes the appearance, dimensions, ports, indicators, and specifications of the PSE injector.

1.3.2.1 PSE Injector

The PSE injector supplies power to a BTS3911B through an Ethernet cable in PoE mode.

Appearance and Dimensions

Figure 1-8 shows the appearance and dimensions of a PSE injector.

Figure 1-8 Appearance and dimensions

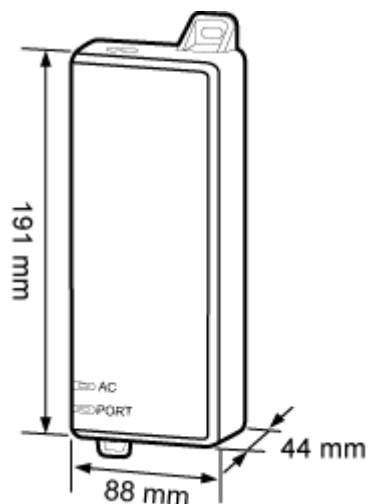

Ports and Indicators

Figure 1-9 shows the ports and indicators on the PSE injector.

Figure 1-9 Ports and indicators

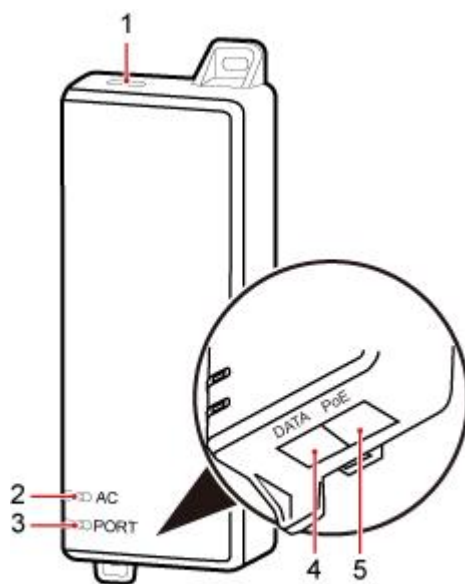

PAP08C0011

Table 1-3 describes ports. **Table 1-4** describes indicators.

Table 1-3 Ports

No.	Silkscreen	Meaning
(1)	Power port	Power input port
(4)	DATA	Data port for connecting to a transmission device
(5)	PoE	PoE port for connecting to the BTS3911B

Table 1-4 Indicators

No.	Silkscreen	Status	Description
(2)	AC	Steady green	Power supply is normal.
		Steady off	There is no power input or the PSE injector is faulty.
(3)	PORT	Steady green	The connection to the BTS3911B is normal.
		Steady off	The connection to the BTS3911B is abnormal or the PSE injector is faulty.

Specifications

Table 1-5 lists PSE injector specifications.

Table 1-5 PSE injector specifications

Item	Specifications
Input voltage	90 V AC to 264 V AC
Input voltage frequency	47 Hz to 63 Hz
Output voltage	- 56 V DC
Maximum output power	65 W

1.3.3 Cables

This section describes cables for BTS3911B installation.

1.3.3.1 Overview

This section describes required cables when a PSE injector is used and cable connections.

Table 1-6 lists the required cables when a PSE injector is used.

Table 1-6 Cables

Cable	One End		The Other End	
	Connector	Installation Position	Connector	Installation Position
1.3.3.2 Ethernet Cable	RJ45 connector	PoE port on the BTS3911B	RJ45 connector	PoE port on the PSE injector
	RJ45 connector	DATA port on the PSE injector	RJ45 connector	Transmission device
1.3.3.3 (Optional) RGPS Signal Cable	RJ45 connector	RGPS port on the BTS3911B	Round 12-pin connector	RGPS device

Figure 1-10 shows cable connections.

Figure 1-10 Cable connections

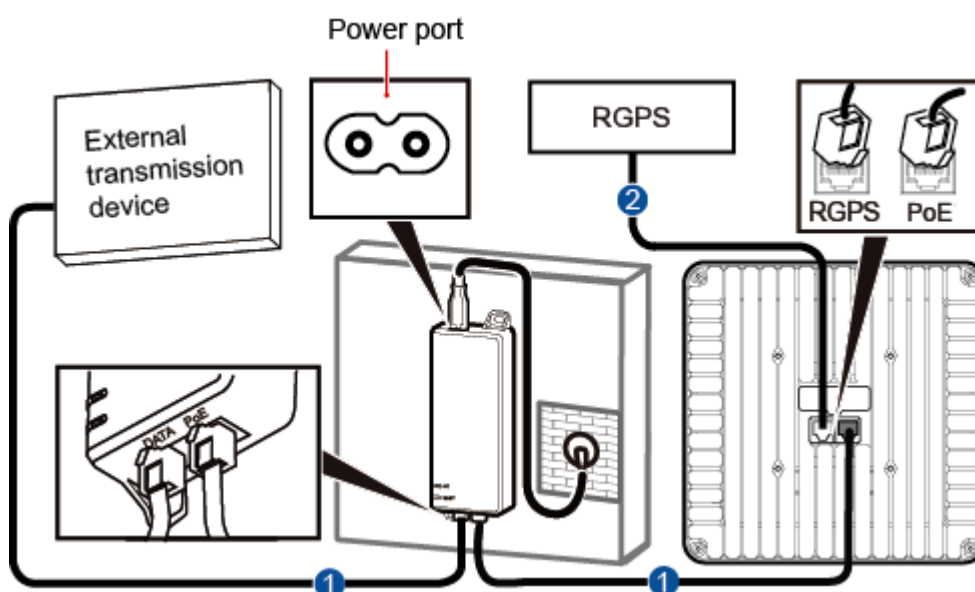

(1) Ethernet cable	(2) RGPS signal cable	-
--------------------	-----------------------	---

NOTE

The total length of cables between the BTS3911B and PSE injector and between the PSE injector and transmission device must not exceed 100 m.

1.3.3.2 Ethernet Cable

This section describes the appearance and pin assignment for an Ethernet cable.

The Ethernet cable connects a BTS3911B to a PSE injector for power supply and data transmission. Ethernet cables are not delivered with the BTS3911B and must be prepared onsite.

NOTE

The Ethernet cable must be at least CAT5e. Its cross-sectional area must be 24 AWG or larger and the flame spread rating must not exceed CM.

Both ends of an Ethernet cable use RJ45 connectors, as shown in [Figure 1-11](#).

Figure 1-11 Appearance of an Ethernet cable



(1) RJ45 connector

Ethernet cables can be straight-through cables or crossover cables. [Table 1-7](#) describes the pin assignment for the wires of an Ethernet cable.

Table 1-7 Pin assignment for the wires of an Ethernet cable

Pin of the RJ45 Connector	Color	Core Wire	Pin of the RJ45 Connector on a Straight-through Cable	Pin of the RJ45 Connector on a Crossover Cable
X1.2	Orange	Twisted pair	X2.2	X2.6
X1.1	White and orange		X2.1	X2.3

Pin of the RJ45 Connector	Color	Core Wire	Pin of the RJ45 Connector on a Straight-through Cable	Pin of the RJ45 Connector on a Crossover Cable
X1.6	Green	Twisted pair	X2.6	X2.2
X1.3	White and green		X2.3	X2.1
X1.4	Blue	Twisted pair	X2.4	X2.4
X1.5	White and blue		X2.5	X2.5
X1.8	Brown	Twisted pair	X2.8	X2.8
X1.7	White and brown		X2.7	X2.7

1.3.3.3 (Optional) RGPS Signal Cable

The RGPS signal cable is used between a BTS3911B and an RGPS device for clock synchronization. This cable is optional.

An RGPS signal cable has an RJ45 connector at one end and a round 12-pin connector at the other end, as shown in [Figure 1-12](#).

Figure 1-12 Appearance of an RGPS signal cable

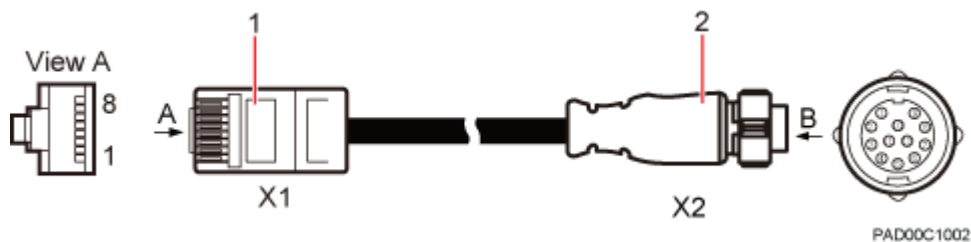

(1) RJ45 connector	(2) Round 12-pin connector
--------------------	----------------------------

[Table 1-8](#) describes the pin assignment for the wires of an RGPS signal cable.

Table 1-8 Pin assignment for the wires of an RGPS signal cable

X1	X2	Wire Color	Wire
X1.1	X2.1	White and orange	Twisted pair

X1	X2	Wire Color	Wire
X1.2	X2.9	Orange	
X1.3	X2.5	White and green	Twisted pair
X1.6	X2.4	Green	
X1.5	X2.3	White and blue	Twisted pair
X1.4	X2.2	Blue	
X1.7	X2.11	White and brown	Twisted pair
X1.8	X2.12	Brown	

1.4 O&M

The O&M system manages, monitors, and maintains BTS3911B software, hardware, and configuration data.

1.4.1 O&M Modes and System

This section describes the O&M modes and O&M system for the BTS3911B.

The BTS3911B supports two O&M modes:

- Remote maintenance on the U2000 at the OMC
- Local maintenance on the LMT through Wi-Fi in the event of a disconnection between the BTS3911B and the U2000

Figure 1-13 shows the O&M system for the BTS3911B.

Figure 1-13 O&M system for the BTS3911B

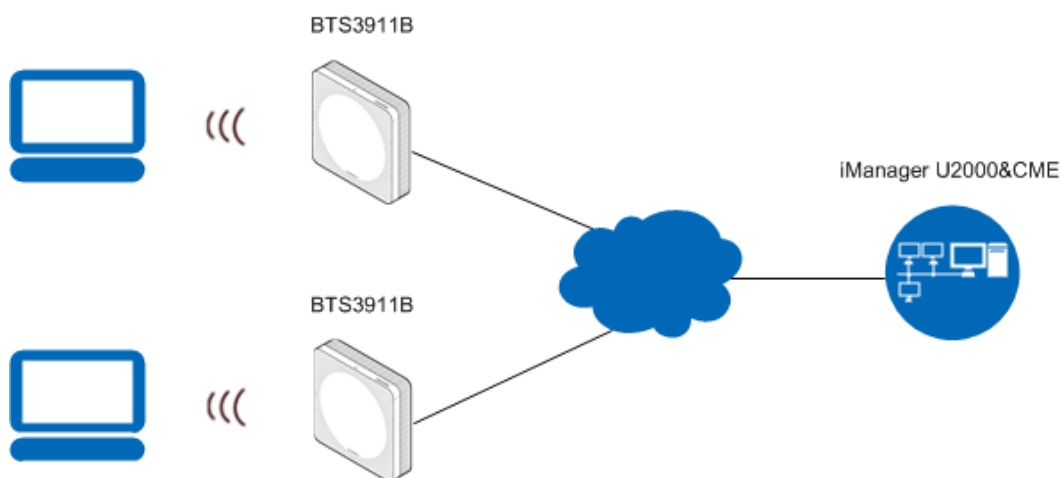

An O&M system of the BTS3911B includes the following elements:

- LMT
Used to locally manage a single base station, including status and alarm query, and PnP tracing. You can log in to the LMT over Wi-Fi.
- U2000
Used to manage multiple base stations remotely.
- CME
Used to configure and manage base station data.

1.4.2 O&M Functions

A variety of O&M functions are available for the BTS3911B.

Configuration Management

Configuration management is used to configure network resources by using configuration data for network devices. This function allows you to control the running status of network devices and is required during the entire network O&M cycle.

- During network deployment, configuration management is used to initialize configuration data, and install and set up network devices. BTS3911Bs support regional deployment and site deployment.
 - Regional deployment
BTS3911Bs in the same region share the common parameter settings, and automatic network planning completes the specific parameter settings.
 - Site deployment
The CME can be used to deploy BTS3911Bs in scenarios applicable to operator-specific private networks, small-scale BTS3911B deployment, and where regional deployment is not supported.
- During network adjustment, optimization, or routine O&M, configuration management is used to do the following:
 - Configure parameters for new features.
 - Modify parameter settings for scenarios, such as network capacity expansion, transmission adjustment, and wireless network performance optimization.
 - Monitor and modify network parameters.

Fault Management

The O&M system manages faults related to hardware, environment, software, transmission, cells, and services. Fault management involves the following functions:

- Fault detection
Allows viewing faults on the device panel and perform simple operations.
- Fault isolation
Prevents faults from affecting the operational continuity of the BTS3911B.
- Self-healing
Minimizes the impact of faults on services by lowering specifications or reestablishing cells.

- Alarm correlation
Enables BTS3911Bs to report only the root fault and the ultimate impact on services.

Performance Management

Performance management involves periodic performance measurement on the BTS3911B, and collection, storage, and reporting of measurement results

Tracing Management

Tracing management facilitates routine maintenance, commissioning, and troubleshooting by collecting the following:

- Internal messages
- Messages exchanged over interfaces, signaling links, and UEs

Signaling messages are traced either on the U2000 or on the LMT.

- Tracing on the U2000
 - Message reporting
The BTS3911B reports signaling messages directly to the U2000.
 - File reporting
The BTS3911B saves signaling messages as a file and then reports the file to the U2000 periodically.
- Tracing on the LMT supports only message reporting.

Security Management

Security management implements user authentication and access control. It includes the following functions:

- User account management
- Rights management
- Login management
- Identity authentication
- Operation authentication

Security control on the transmission channels between the BTS3911B and the U2000 supports the following:

- IPsec
- Secure Socket Layer (SSL)
- Public Key Infrastructure (PKI)
- Datagram Transport Layer Security (DTLS)

Security management provides network- and user-specific security services. It provides the following functions:

- Encryption
Encrypts important user information.

- Authentication
Manages and authenticates user accounts.
- Access control
Controls user operations.
- Security protocol
Supports SSL.

Software Management

Software management involves the following functions:

- Software version management
Software versions can be queried and restored.
- Software version upgrade
BTS3911Bs can be remotely upgraded in batches. With the one-click remote upgrade wizard provided by the U2000, you can:
 - Perform health checks before and after upgrades.
 - Download and activate software.
 - Check the upgrade status and results.BTS3911Bs support automatic configuration updates during upgrades. To perform an upgrade, follow the instructions on the upgrade wizard. To reduce the impact of upgrade failures, roll back the software version by running a single command.
- Patch management
Involves patch query, download, activation, deactivation, rollback, and removal.

Inventory Management

Inventory management involves the collection and reporting of BTS3911B inventory information to manage network equipment assets at the OMC.

1.5 Specifications

This section describes the technical specifications and reliability of the BTS3911B.

1.5.1 Technical Specifications

This section provides BTS3911B technical specifications, including supported modes and frequency bands, RF specifications, capacity specifications, output power and power consumption, Wi-Fi specifications, equipment specifications, environment specifications, standards compliance, and surge protection specifications.

Supported Modes and Frequency Bands

[Table 1-9](#) lists the modes and frequency bands supported by a BTS3911B.

Table 1-9 Modes and frequency bands supported by a BTS3911B

Scenario	Mode	Frequency Band (MHz)	RX Frequency Band (MHz)	TX Frequency Band (MHz)	Supported Bandwidth (MHz)	IBW (MHz)
1800 MHz LTE (FDD)	LTE (FDD)	1800	1710 to 1785	1805 to 1880	5/10/15/20	20
2100 MHz LTE (FDD)	LTE (FDD)	2100	1920 to 1980	2110 to 2170	5/10/15/20	20
2100 MHz UMTS	UMTS	2100	1920 to 1980	2110 to 2170	5	20
2600 MHz LTE (FDD)	LTE (FDD)	2600	2500 to 2570	2620 to 2690	5/10/15/20	20
2100 MHz LTE (FDD)+2100 MHz UMTS	LTE (FDD)	2100	1920 to 1980	2110 to 2170	5/10/15	20
	UMTS	2100	1920 to 1980	2110 to 2170	5	20
1800 MHz LTE (FDD)+2100 MHz LTE (FDD)	LTE (FDD)	1800	1710 to 1785	1805 to 1880	5/10/15/20	20
	LTE (FDD)	2100	1920 to 1980	2110 to 2170	5/10/15/20	20
1800 MHz LTE (FDD)+2100 MHz UMTS	LTE (FDD)	1800	1710 to 1785	1805 to 1880	5/10/15/20	20
	UMTS	2100	1920 to 1980	2110 to 2170	5	20
2100 MHz LTE (FDD)+2600 MHz LTE (FDD)	LTE (FDD)	2100	1920 to 1980	2110 to 2170	5/10/15/20	20
	LTE (FDD)	2600	2500 to 2570	2620 to 2690	5/10/15/20	20
2100 MHz UMTS+2600 MHz LTE (FDD)	UMTS	2100	1920 to 1980	2110 to 2170	5	20
	LTE (FDD)	2600	2500 to 2570	2620 to 2690	5/10/15/20	20
AWS LTE (FDD)	LTE (FDD)	AWS	1710 to 1755	2110 to 2155	5/10/15/20	20
PCS LTE (FDD)	LTE (FDD)	PCS	1850 to 1910	1930 to 1990	5/10/15/20	20
AWS UMTS	UMTS	AWS	1710 to 1755	2110 to 2155	5	20

Scenario	Mode	Frequency Band (MHz)	RX Frequency Band (MHz)	TX Frequency Band (MHz)	Supported Bandwidth (MHz)	IBW (MHz)
PCS UMTS	UMTS	PCS	1850 to 1910	1930 to 1990	4.2/5	20
AWS LTE (FDD)+PCS LTE (FDD)	LTE (FDD)	AWS	1710 to 1755	2110 to 2155	5/10/15/20	20
	LTE (FDD)	PCS	1850 to 1910	1930 to 1990	5/10/15/20	20
AWS LTE (FDD)+AWS UMTS	LTE (FDD)	AWS	1710 to 1755	2110 to 2155	5/10/15/20	20
	UMTS	AWS	1710 to 1755	2110 to 2155	5	20
PCS LTE (FDD)+PCS UMTS	LTE (FDD)	PCS	1850 to 1910	1930 to 1990	5/10/15/20	20
	UMTS	PCS	1850 to 1910	1930 to 1990	5	20
AWS LTE (FDD)+PCS UMTS	LTE (FDD)	AWS	1710 to 1755	2110 to 2155	5/10/15/20	20
	UMTS	PCS	1850 to 1910	1930 to 1990	4.2/5	20

RF Specifications

The UMTS receiver sensitivity is measured at the antenna connector under the conditions recommended in 3GPP TS 25.104:

- The channel rate is 12.2 kbit/s.
- The bit error rate does not exceed 0.001.

The LTE receiver sensitivity is measured under the conditions recommended in annex A in 3GPP TS 36.104:

- The channel bandwidth is 5 MHz.
- The reference measurement channel is FRC A1-3 in annex A.1 (QPSK, R = 1/3, 25 RBs).

Table 1-10 describes the TX/RX channel and receiver sensitivity of a BTS3911B.

Table 1-10 TX/RX channel and receiver sensitivity

Mode	Frequency Band (MHz)	TX/RX Channel	Single-antenna Receiver Sensitivity (dBm)	Dual-antenna Receiver Sensitivity (dBm)
LTE FDD	1800	2T2R	- 94.0	- 96.8
	2100	2T2R	- 94.0	- 96.8
	2600	2T2R	- 94.0	- 96.8
	AWS	2T2R	- 94.0	- 96.8
	PCS	2T2R	- 94.0	- 96.8
UMTS	2100	1T2R	- 112.0	- 114.8
	AWS	1T2R	- 112.0	- 114.8
	PCS	1T2R	- 112.0	- 114.8

Table 1-11 lists the mapping between frequency bands and TX/RX channel numbers by the BTS3911B.

Table 1-11 Mapping between frequency bands and TX/RX channel numbers

Scenario	Frequency Band (MHz)	TX/RX Channel No.
AWS+PCS	AWS	TX0/RX0
		TX1/RX1
	PCS	TX2/RX2
		TX3/RX3
2100 MHz+2600 MHz	2100	TX0/RX0
		TX1/RX1
	2600	TX2/RX2
		TX3/RX3
2100 MHz+1800 MHz	2100	TX0/RX0
		TX1/RX1
	1800	TX2/RX2
		TX3/RX3

Table 1-12 lists the internal antenna specifications.

Table 1-12 Internal antenna specifications

Frequency Band (MHz)	Gain (dBi)	Polarization Mode	Directionality
1800	2	Linear	Omnidirectional
2100	2	Linear	Omnidirectional
2600	3	Linear	Omnidirectional
AWS	2	Linear	Omnidirectional
PCS	2	Linear	Omnidirectional

Capacity Specifications

Table 1-13 Capacity specifications in LTE only mode

Item	Specifications
Maximum number of cells per BTS3911B	<ul style="list-style-type: none"> ● Single-band: One 20 MHz cell ● Dual-band: Two 20 MHz cells
Maximum number of UEs in RRC_Connected mode	<ul style="list-style-type: none"> ● For a cell: 192 ● For a BTS3911B: 384
Maximum throughput	For a cell: <ul style="list-style-type: none"> ● Downlink: 195 Mbit/s ● Uplink: 71 Mbit/s For a BTS3911B: <ul style="list-style-type: none"> ● Downlink: 390 Mbit/s ● Uplink: 142 Mbit/s
Maximum number of concurrent data radio bearers (DRBs) per UE	8
Maximum number of concurrent DRBs	<ul style="list-style-type: none"> ● For a cell: 576 ● For a BTS3911B: 1152

Table 1-14 Capacity specifications in UMTS only mode

Item	Specifications
Maximum number of cells per BTS3911B	One cell
Maximum number of CEs per BTS3911B	<ul style="list-style-type: none"> ● Downlink: 32 CEs ● Uplink: 32 CEs
Maximum number of UEs per BTS3911B	32 HSPA UEs

Item	Specifications
Maximum throughput per BTS3911B	<ul style="list-style-type: none"> ● Downlink: 21 Mbit/s ● Uplink: 5.76 Mbit/s

Table 1-15 Capacity specifications in UMTS+LTE mode

Item	UMTS Specifications	LTE Specifications
Maximum number of cells per BTS3911B	One cell	One 20 MHz cell
Maximum number of CEs per BTS3911B	<ul style="list-style-type: none"> ● Downlink: 32 CEs ● Uplink: 32 CEs 	-
Maximum number of UEs per BTS3911B	32 HSPA UEs	192 UEs in RRC_Connected mode
Maximum throughput per BTS3911B	<ul style="list-style-type: none"> ● Downlink: 21 Mbit/s ● Uplink: 5.76 Mbit/s 	<ul style="list-style-type: none"> ● Downlink: 195 Mbit/s ● Uplink: 71 Mbit/s
Maximum number of concurrent DRBs per UE	-	8
Maximum number of concurrent DRBs	-	576

Output Power and Power Consumption

Table 1-16 Output power and power consumption

Maximum Output Power	Power Consumption
<ul style="list-style-type: none"> ● Single-band: 2 x 125 mW ● Dual-band: 2 x 2 x 125 mW 	<ul style="list-style-type: none"> ● Single-band+Wi-Fi: 47 W ● Dual-band+Wi-Fi: 54 W

NOTE

- "Single-band+Wi-Fi" provides power consumption on a cellular band and a Wi-Fi band when the power amplifier (PA) of the other cellular band is disabled for a dual-band BTS3911B.
- In the **Maximum Output Power (W)** column, *AxB* indicates that the BTS3911B is configured with *A* TX channels and the maximum output power per channel is *B* W. *CxDxE* indicates that a BTS3911B provides *C* frequency bands with *D* TX channels per band and *E* W output power per channel.
- The supported power for a BTS3911B ranges from 12.5 mW to 125 mW. The static power class is 10 dB. If the power class exceeds 10 dB, radio performance cannot be ensured and the reconfigured power must fall into the supported range.
- When the total distance between a dual-band+Wi-Fi BTS3911B and transmission device is 100 m, the maximum input power of a PSE injector is 70 W.

Wi-Fi Specifications

Table 1-17 Wi-Fi specifications

Item	Specifications
Supported frequency band	<ul style="list-style-type: none"> ● 2.4 GHz: 2.4000 GHz to 2.4835 GHz ● 5 GHz: 5.15 GHz to 5.35 GHz, 5.470 GHz to 5.725 GHz, and 5.725 GHz to 5.850 GHz
Antenna gain	<ul style="list-style-type: none"> ● 2.4 GHz: 3 dBi ● 5 GHz: 7 dBi
TX power	<ul style="list-style-type: none"> ● 802.11n: 16 dBm ● 802.11ac: 14 dBm
EIRP	<ul style="list-style-type: none"> ● 2.4 GHz: 24 dBm ● 5 GHz: 28 dBm
Maximum throughput	<ul style="list-style-type: none"> ● 2.4 GHz: 450 Mbit/s ● 5 GHz: 1300 Mbit/s
Standards compliance	<ul style="list-style-type: none"> ● 2.4 GHz: 802.11b/g/n ● 5 GHz: 802.11a/n/ac
MIMO	3T3R
Maximum number of associated UEs	256
Polarization mode	Linear
Directionality	Omnidirectional

 **NOTE**

For a BTS3911B working at 2600 MHz, its 2.4 GHz Wi-Fi module cannot not use channel 12 or 13.

Transmission Port Specifications

Table 1-18 Transmission port specifications

Transmission Port Type	Number of Ports
FE/GE electrical port	1

Equipment Specifications

Table 1-19 Equipment specifications

Item	Specifications
Dimensions (H x W x D)	200 mm x 200 mm x 55 mm (2.2 L)
Weight	2 kg (with internal antenna)
EOS	8 years
Availability	0.99999899

Environment Specifications

Table 1-20 Environment specifications

Item	Specifications
Operating temperature	- 5°C to +40°C
Relative humidity	5% RH to 95% RH
Absolute humidity	1 to 30 g/m ³
Altitude	Functional from - 60 m to 1800 m Able to work from 1800 m to 4000 m
Operating pressure	70 kPa to 106 kPa
Operating environment	Storage environment: ETS 300 019-1-1 Class 1.2 Transportation environment: ETS 300 019-1-2 Class 2.3 Application environment: ETS 300 019-1-3 Class 3.2
IP rating	IP20
Shockproof capability	GR63 ZONE4 suitability requirements
Protection from damp, mold, and salt-spray fog	IEC60950

 **NOTE**

It is recommended that the device be installed and used within one year after its delivery. Failure rates increase after one year if the device is not installed.

Standards Compliance

Table 1-21 Standards compliance

Item	Specifications
EMC	<ul style="list-style-type: none"> ● CISPR 22 ● EN 55022 ● EN 301 489-17 ● EN 301 489-23 ● CISPR 24 ● IEC 61000-4-2 ● IEC 61000-4-3 ● IEC 61000-4-4 ● IEC 61000-4-5 ● IEC 61000-4-6 ● IEC 61000-4-29 ● GB 9254 ● ETSI 301 489-1 ● VCCI V-3
3GPP	<ul style="list-style-type: none"> ● Release 99 ● Release 4 ● Release 5 ● Release 6 ● Release 7 ● Release 8 ● Release 9 ● Release 10
Environmental protection standard	RoHS
Surge protection standards	<ul style="list-style-type: none"> ● IEC 61000-4-5 ● YD 5098
Protection standards	<ul style="list-style-type: none"> ● IEC 61000-4-5 ● YD 5068-98 ● YD 5098

Item	Specifications
Safety standards	<ul style="list-style-type: none"> ● AS/NZS60950-1 ● AS/NZS60950-22 ● EN 60950-1 ● EN 60950-22 ● IEC 60950-1 ● IEC 60950-22 ● UL60950-1 ● UL60950-22
Environmental standards	<ul style="list-style-type: none"> ● IEC60068-2-2 ● ETSI EN300019-1-1 ● ETSI EN300019-1-2 ● ETSI EN300019-1-3 ● ETSI EN300019-2-1 ● ETSI EN300019-2-2 ● ETSI EN300019-2-3
ETL	<p>Conforms to UL STD.60950-1 CERTIFIED TO CSA STD.C22.2 NO.60950-1</p> <p>The following figure shows the identity of ETL:</p> 

Surge Protection Specifications for Ports

Table 1-22 Surge protection specifications for ports

Port	Surge Protection Mode	Surge Protection Specifications
PoE	Differential mode	±0.5 kV (1.2/50 μs)
	Common mode	±2 kV (1.2/50 μs)
RGPS	Differential mode	±0.5 kV (1.2/50 μs)

1.5.2 Typical Power Configuration

This section provides typical power configurations.

A BTS3911B can work in UMTS only, LTE FDD only, or UMTS+LTE mode, where:

- A BTS3911B working in UMTS only mode can be configured with a maximum of one carrier.
- A BTS3911B working in LTE FDD only mode can be configured with a maximum of two carriers with a maximum of one LTE carrier on one frequency band.
- A BTS3911B working in UMTS+LTE FDD mode can be configured with a maximum of one UMTS carrier plus one LTE carrier.

Table 1-23 and **Table 1-24** provide typical power configuration for the BTS3911B (LTE FDD, 1800 MHz/2100 MHz/2600 MHz/AWS/PCS).

Table 1-25 and **Table 1-26** provide typical power configuration for the BTS3911B (UMTS, 2100 MHz/2600 MHz/AWS).

Table 1-27 and **Table 1-28** provide typical power configuration for the BTS3911B (UMTS, PCS).

Table 1-29 and **Table 1-30** provide typical power configuration for the BTS3911B (UMTS +LTE, 2100 MHz/AWS/PCS).

Table 1-31 and **Table 1-32** provide typical power configuration for the BTS3911B (LTE FDD PCS+LTE FDD AWS), BTS3911B (LTE FDD 2100 MHz+LTE FDD 2600 MHz)/(LTE FDD 2100 MHz+LTE FDD 1800 MHz).

Table 1-33 and **Table 1-34** provide typical power configuration for the BTS3911B (UMTS PCS+LTE FDD AWS).

Table 1-35 and **Table 1-36** provide typical power configuration for the BTS3911B (UMTS 2100 MHz+LTE FDD 2600 MHz)/(UMTS 2100 MHz+LTE FDD 1800 MHz).

Table 1-23 Typical power configuration for the BTS3911B (LTE FDD, 1800 MHz/2100 MHz/2600 MHz/AWS/PCS)

Mode	Number of LTE FDD Carriers	Output Power per LTE FDD Carrier (mW)	Supported LTE FDD Cell Bandwidth (MHz)
LTE FDD	1 (MIMO)	2x125	5/10/15/20

Table 1-24 Typical power configuration for BTS3911B PAs (LTE FDD, 1800 MHz/2100 MHz/2600 MHz/AWS/PCS)

Carrier Configuration	PA1		PA2	
	Total Number of LTE FDD Carriers	Output Power per LTE FDD Carrier (mW)	Total Number of LTE FDD Carriers	Output Power per LTE FDD Carrier (mW)
One LTE FDD carrier (MIMO)	1	125	1	125

Table 1-25 Typical power configuration for the BTS3911B (UMTS, 2100 MHz/2600 MHz/AWS)

Mode	Number of UMTS Carriers	Output Power per UMTS Carrier (mW)	Supported UMTS Cell Bandwidth (MHz)
UMTS	1	125	5

Table 1-26 Typical power configuration for BTS3911B PAs (UMTS, 2100 MHz/2600 MHz/AWS)

Carrier Configuration	PA1		PA2	
	Total Number of UMTS Carriers	Output Power per UMTS Carrier (mW)	Total Number of UMTS Carriers	Output Power per UMTS Carrier (mW)
1	1	125	0	0

Table 1-27 Typical power configuration for the BTS3911B (UMTS, PCS)

Mode	Number of UMTS Carriers	Output Power per UMTS Carrier (mW)	Supported UMTS Cell Bandwidth (MHz)
UMTS	1	125	4.2/5

Table 1-28 Typical power configuration for BTS3911B PAs (UMTS, PCS)

Carrier Configuration	PA1		PA2	
	Total Number of UMTS Carriers	Output Power per UMTS Carrier (mW)	Total Number of UMTS Carriers	Output Power per UMTS Carrier (mW)
1	1	125	0	0

Table 1-29 Typical power configuration for the BTS3911B (UMTS+LTE, 2100 MHz/AWS/PCS)

Mode	Total Number of UMTS Carriers	Total Number of LTE FDD Carriers	Output Power per UMTS Carrier (mW)	Supported UMTS Cell Bandwidth (MHz)	Output Power per LTE FDD Carrier (mW)	Supported LTE FDD Cell Bandwidth (MHz)
UMTS+LTE FDD	1	1 (MIMO)	50	5	2x50	5/10/15

Table 1-30 Typical power configuration for BTS3911B PAs (UMTS+LTE, 2100 MHz/AWS/PCS)

Carrier Configuration	PA1				PA2			
	Total Number of UMTS Carriers	Output Power per UMTS Carrier (mW)	Total Number of LTE FDD Carriers	Output Power per LTE FDD Carrier (mW)	Total Number of UMTS Carriers	Output Power per UMTS Carrier (mW)	Total Number of LTE FDD Carriers	Output Power per LTE FDD Carrier (mW)
One UMTS carrier +one LTE FDD carrier (MIMO)	1	50	1	50	0	0	1	50

Table 1-31 Typical power configuration for the BTS3911B (LTE FDD PCS+LTE FDD AWS)/(LTE FDD 2100 MHz+LTE FDD 2600 MHz)/(LTE FDD 2100 MHz+LTE FDD 1800 MHz)

Mode	Total Number of LTE FDD Carriers on One Frequency Band	Output Power per LTE FDD Carrier on One Frequency Band (mW)	Total Number of LTE FDD Carriers on the Other Frequency Band	Output Power per LTE FDD Carrier on the Other Frequency Band (mW)	Supported LTE FDD Cell Bandwidth (MHz)
LTE FDD	1 (MIMO)	2x125	1 (MIMO)	2x125	5/10/15/20

Table 1-32 Typical power configuration for BTS3911B PAs (LTE FDD PCS+LTE FDD AWS)/(LTE FDD 2100 MHz+LTE FDD 2600 MHz)/(LTE FDD 2100 MHz+LTE FDD 1800 MHz)

Carrier Configuration	PA1 (One Frequency Band)		PA2 (One Frequency Band)		PA1 (the Other Frequency Band)		PA2 (the Other Frequency Band)	
	Total Number of LTE FDD Carriers	Output Power per LTE FDD Carrier (mW)	Total Number of LTE FDD Carriers	Output Power per LTE FDD Carrier (mW)	Total Number of LTE FDD Carriers	Output Power per LTE FDD Carrier (mW)	Total Number of LTE FDD Carriers	Output Power per LTE FDD Carrier (mW)
Two LTE FDD carriers (MIMO)	1	125	1	125	1	125	1	125

Table 1-33 Typical power configuration for the BTS3911B (UMTS PCS+LTE FDD AWS)

Mode	Total Number of UMTS Carriers	Total Number of LTE FDD Carriers	Output Power per UMTS Carrier (mW)	Supported UMTS Cell Bandwidth (MHz)	Output Power per LTE FDD Carrier (mW)	Supported LTE FDD Cell Bandwidth (MHz)
UMTS +LTE FDD	1	1 (MIMO)	125	4.2/5	2x125	5/10/15/20

Table 1-34 Typical power configuration for BTS3911B PAs (UMTS PCS+LTE FDD AWS)

Carrier Configuration	PCS PA1		PCS PA2		AWS PA1		AWS PA2	
	Total Number of UMTS Carriers	Output Power per UMTS Carrier (mW)	Total Number of UMTS Carriers	Output Power per UMTS Carrier (mW)	Total Number of LTE FDD Carriers	Output Power per LTE FDD Carrier (mW)	Total Number of LTE FDD Carriers	Output Power per LTE FDD Carrier (mW)

One UMTS carrier+one LTE FDD carrier (MIMO)	1	125	0	0	1	125	1	125
---	---	-----	---	---	---	-----	---	-----

Table 1-35 Typical power configuration for the BTS3911B (UMTS 2100 MHz+LTE FDD 2600 MHz)/(UMTS 2100 MHz+LTE FDD 1800 MHz)

Mode	Total Number of UMTS Carriers	Total Number of LTE FDD Carriers	Output Power per UMTS Carrier (mW)	Supported UMTS Cell Bandwidth (MHz)	Output Power per LTE FDD Carrier (mW)	Supported LTE FDD Cell Bandwidth (MHz)
UMTS +LTE FDD	1	1 (MIMO)	125	5	2x125	5/10/15/20

Table 1-36 Typical power configuration for BTS3911B PAs (UMTS 2100 MHz+LTE FDD 2600 MHz)/(UMTS 2100 MHz+LTE FDD 1800 MHz)

Carrier Configuration	2100 MHz PA1		2100 MHz PA2		1800 MHz/2600 MHz PA1		1800 MHz/2600 MHz PA2	
	Total Number of UMTS Carriers	Output Power per UMTS Carrier (mW)	Total Number of UMTS Carriers	Output Power per UMTS Carrier (mW)	Total Number of LTE FDD Carriers	Output Power per LTE FDD Carrier (mW)	Total Number of LTE FDD Carriers	Output Power per LTE FDD Carrier (mW)
One UMTS carrier+one LTE FDD carrier (MIMO)	1	125	0	0	1	125	1	125

1.5.3 Reliability

This section describes hardware reliability and software reliability of a BTS3911B.

System Reliability

System reliability is improved owing to features such as load sharing and configuration redundancy, as well as optimized fault detection and isolation technologies.

- **Redundancy**
Redundancy is supported by units, such as the power supply unit, and key files, such as software versions and configuration files.
- **Reliability**
The system automatically detects and diagnoses faults in the software, hardware, and environment, and reports alarms. Then the system automatically clears the faults using self-healing measures. If the faults cannot be cleared, the faulty units will be automatically isolated.

Hardware Reliability

- **Over-temperature protection**
The BTS3911B reports an over-temperature alarm when its PA temperature is too high and performs either of the following:
 - If the temperature is higher than the threshold for a major alarm, the BTS3911B automatically turns off the PA and stops providing services. This protects the BTS3911B from over-temperature damage.
 - If the temperature is higher than the threshold for a minor alarm, the BTS3911B enables the temperature derating function. This ensures the services of admitted UEs and refuses the access requests of new UEs to prevent the temperature from increasing.
- **Reliable power supply**
The BTS3911B uses the following techniques to achieve a reliable power supply:
 - Support for a wide-range of voltages as well as surge protection
 - Power failure protection for programs and data
 - Protection of power supply against overvoltage and overcurrent
- **Surge protection design**
The BTS3911B adopts surge protection for the PoE power port and RGPS clock port.

Software Reliability

- **Redundancy**
To ensure normal operation of a BTS3911B when errors occur in important files or data, the BTS3911B provides the following redundancy functions:
 - **Software version redundancy**
The BTS3911B stores software versions, including the BootROM version, in different partitions to provide redundancy. If the active version is abnormal, the BTS3911B switches to the backup version.
 - **Configuration file redundancy**
The BTS3911B stores configuration files in different partitions to provide redundancy. If the in-use file is damaged, the BTS3911B can continue working properly by loading the backup file.
- **Error tolerance capability**
If software errors occur, the self-healing capability prevents BTS3911Bs from crashing. The software error tolerance capability covers the following aspects:
 - Scheduled checks of key resources

The BTS3911B checks software resource usage and generates related logs and alarms, allowing the BTS3911B to release resources.

- Task monitoring

The BTS3911B monitors the running status of every task for errors and faults. If an error or fault is detected, an alarm is reported and self-healing measures are taken to restore the task.

- Data check

The BTS3911B checks data consistency when scheduled or triggered by events. It can selectively or preferentially restore data consistency. In addition, the BTS3911B generates related logs and alarms.

- Watchdog

If an error occurs in a BTS3911B, the BTS3911B detects the error using the software and hardware watchdogs and automatically restarts.